

Data Sheet



Article number: 021300705021

Description: Sealing Clamp S 21 W5

Measures

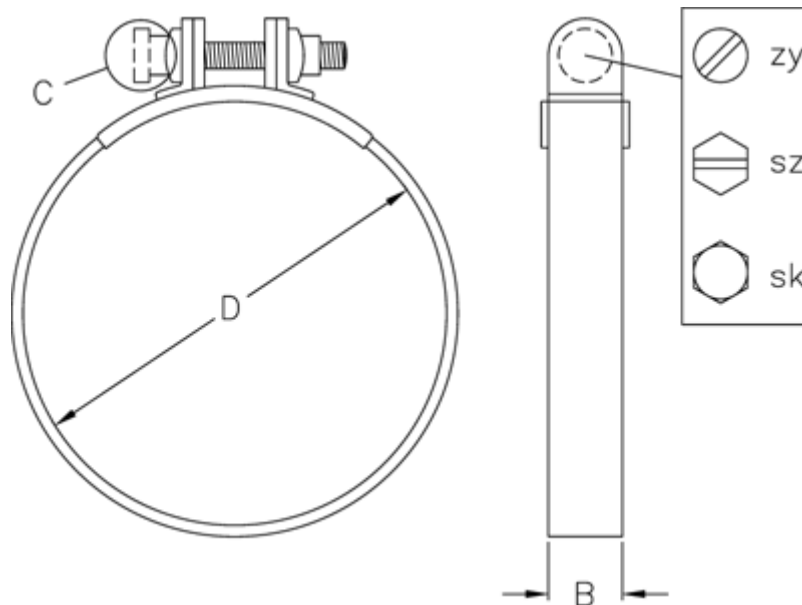

C (screw type) = SZ

Diameter D = 21

Width B = 12